

Y 211 t/m 222 (5 kW)  
138 t/m 149 (3kW)

Y 235, 236 (5kW)  
162 t/m 169 (3kW)

Y 223 t/m 234 (5 kW)  
150 t/m 161 (3kW)

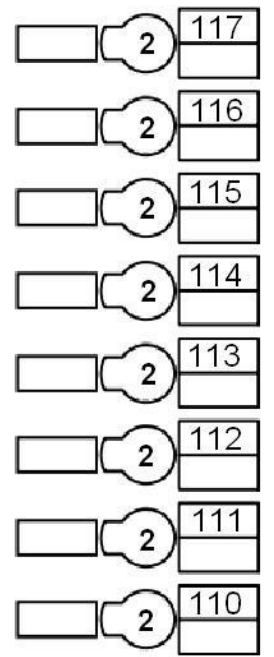

Horizonbatterij						
	191	195	175	179	183	187
	192	196	176	180	184	188
	193	197	177	181	185	189
	194	198	178	182	186	190

### Zijbrug Links

Harting zijbrug links  
102 t/m 109

### Zijbrug Rechts

Harting zijbrug rechts  
118 t/m 125

### Manteau Links boven

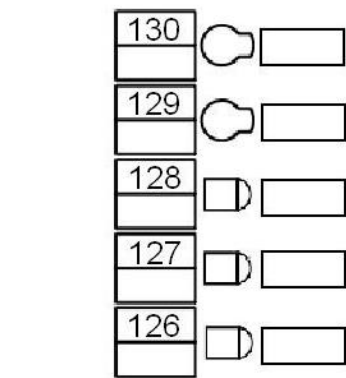

### Portaal onder

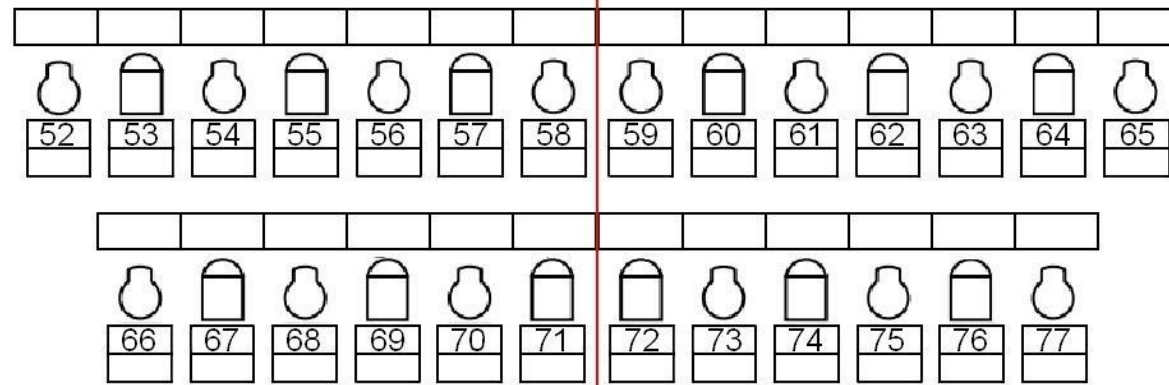

### Manteau Rechts boven

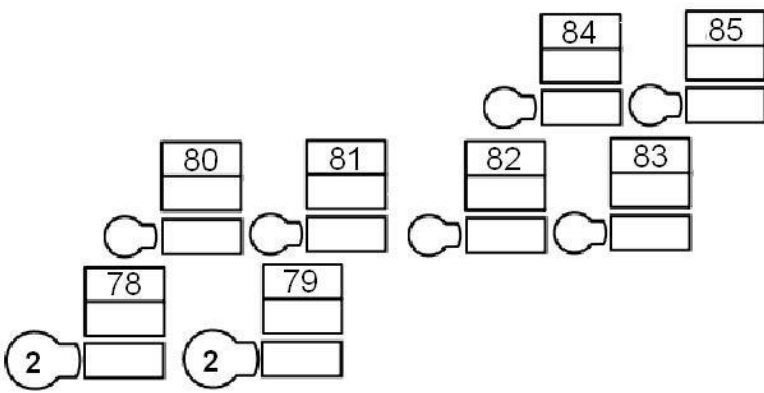
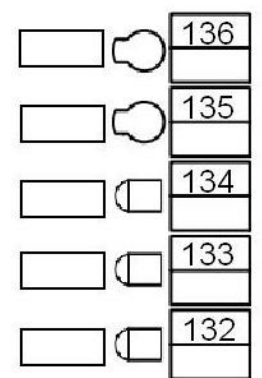

### Koof Links

### Prosceniumbrug

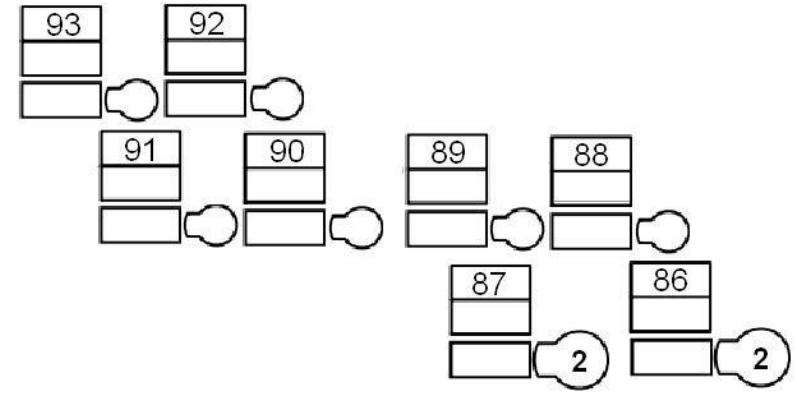

### Koof Rechts

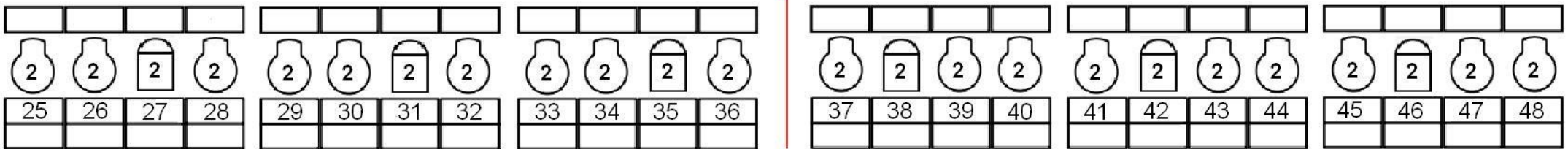



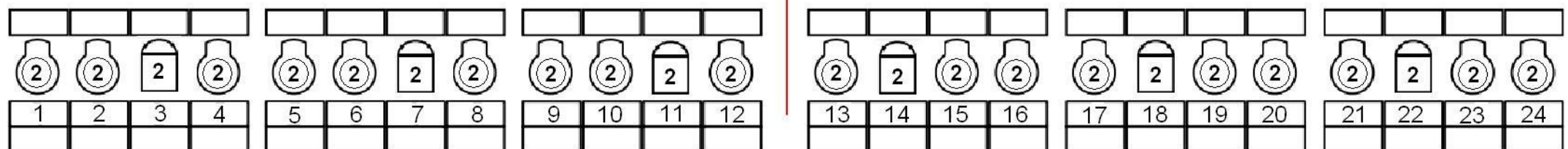







### Eerste Zaalbrug



### Tweede Zaalbrug



<b>Armaturen</b> PC 1 kW  PC 2 kW  Fresnel 1 kW  Sixbar 1 kW  Par 64 	<b>Armaturen</b> Profiel z 15-38° 1 kW  Profiel z 15-40° 2 kW  Profiel z 10-20° 2 kW  Volgspot HMI 1800W 	<b>Gezelschap:</b> Datum: Zaallicht: 49+51 doeklicht 240 klankkaatsers 241 balkon onder 242 balkon boven 243 uplight muur  <b>Orkestlicht:</b> 170,171 <b>Regiecabine:</b> 172	<b>Voorstelling:</b>  <b>GROTE ZAAL</b> versie 22 januari 2024
---	---	---	--